

4

3

2

1

F

F

E

E

D

D

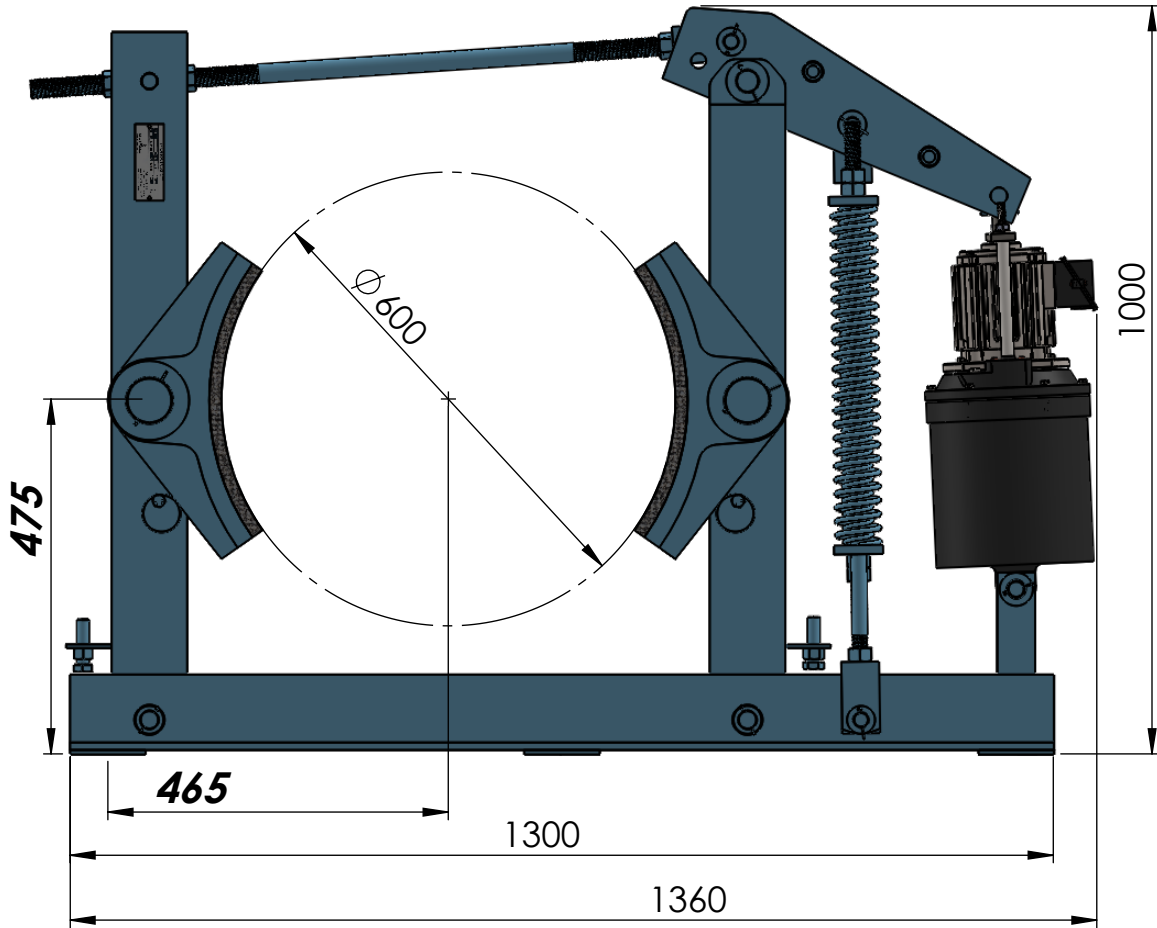

C

C

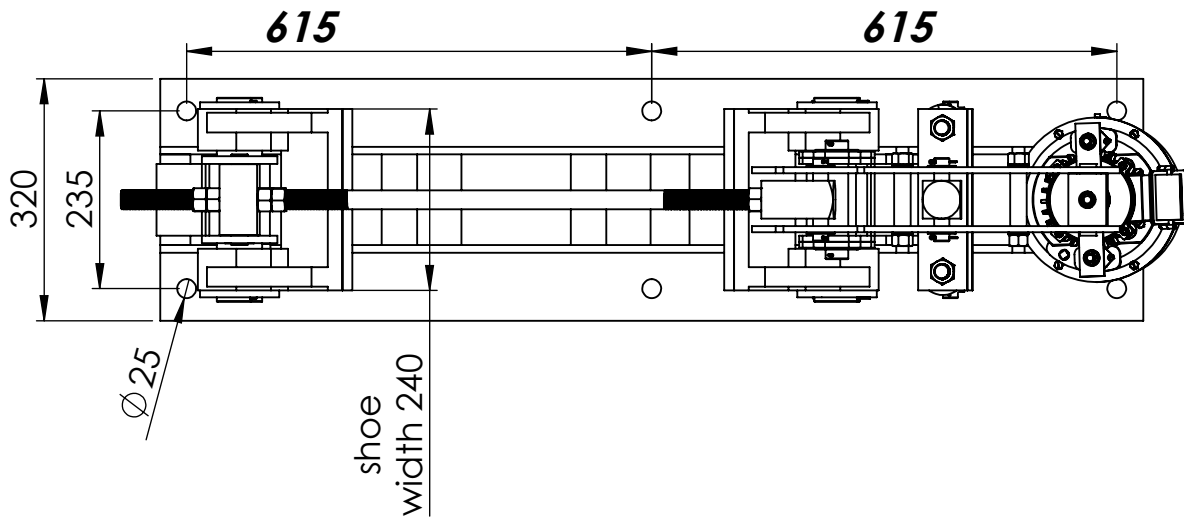

B

B

UNLESS OTHERWISE SPECIFIED:  
DIMENSIONS ARE IN MILLIMETERS  
SURFACE FINISH:  
TOLERANCES:  
LINEAR:  
ANGULAR:

FINISH:

DEBURR AND  
BREAK SHARP  
EDGES

DO NOT SCALE DRAWING

REVISION

Speedage Engineers (India) Pvt. Ltd.

	NAME	SIGNATURE	DATE	CONTACT
DRAWN	Himanshu Tiwari			
CHK'D				
APPV'D	J.A. Raichandani			9810173991
MFG				

TITLE: Thruster Brake MDT 600-114  
Braking Torque: 580Kg.m  
Thruster Stroke: 76mm  
Thruster Capacity: 114Kg

A

A

THIS DRAWING IS THE PROPERTY OF **SPEEDAGE ENGINEERS (INDIA) PVT. LTD.** & MUST NEITHER BE COPIED NOR BE MADE KNOWN TO ANY OTHER PARTY WITHOUT THEIR PRIOR WRITTEN CONSENT.

MATERIAL:

DWG NO.

SAE/DWG/THB/B600\_114/01

A4

WEIGHT:

SCALE:1:10

SHEET 1 OF 1

4

3

2

1